

Article number: 40600805732445

Description: Helical gearbox
C803F-57,3-P112B5

Measures

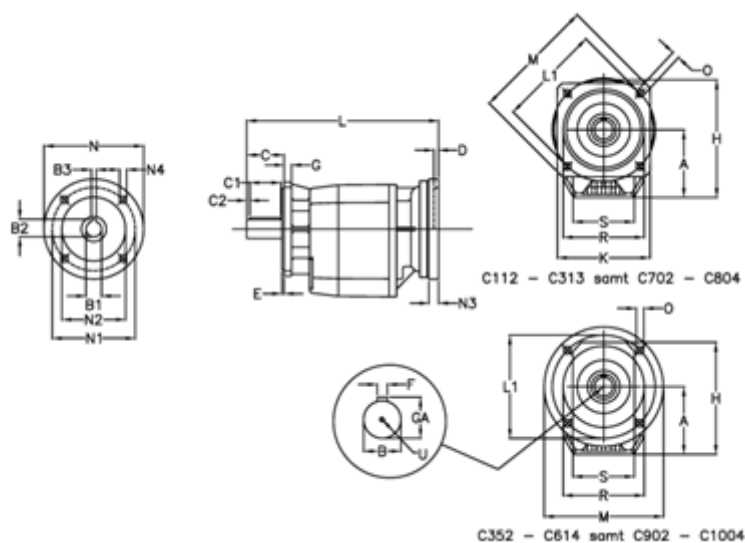

A = 247.0	D = 4.5	L1 = 350	R = 320
B = 80	E = 5	M = 400	S = 300
B1 = 28	F = 22	N = 250	U = M20x42
B2 = 31.3	G = 20	N1 = 215	
B3 = 8	GA = 85.0	N2 = 180	
C = 140	H = 422.0	N3 = 0	
C1 = 110	K = 350	N4 = M12x16	
C2 = 15	L = 543.0	O = 18.0	